

INSTALLATION AND OPERATION GUIDE FOR HARGROVE VENT-FREE GAS LOGS

HIGHLAND GLOW - CHARLESTON GLOW
ELECTRONIC IGNITION PILOT SYSTEM



DESIGN CERTIFIED to
UNVENTED – ANSI Z21.11.2
VENTED - ANSI Z21.60/CGA 2.26



Installation and service must be provided by a qualified installer, service agency or the gas supplier.

NOTE: ADEQUATE FIREPLACE VENTILATION IS REQUIRED FOR SAFETY.
READ INSTRUCTIONS FULLY BEFORE INSTALLING OR OPERATING.
INSTALLER: LEAVE THIS MANUAL WITH THE APPLIANCE.
CONSUMER: RETAIN THIS MANUAL FOR FUTURE REFERENCE.

WARNING:

If the information in this manual is not followed exactly, a fire or explosion may result, causing property damage, personal injury, or loss of life.

WHAT TO DO IF YOU SMELL GAS

1. Open a window.
2. Do not try to light any appliance.
3. Do not touch any electrical switch; do not use the phone in your building.
4. Immediately call your gas supplier from a neighbor's phone. Follow the gas supplier's instructions.
5. If you cannot reach your gas supplier, call the fire department.

FOR YOUR SAFETY

Do not store or use gasoline or other flammable vapors and liquids in the vicinity of this or any other appliance.

IMPORTANT:

Installation and service must be performed by a qualified professional installer, service agency, or the gas supplier. Improper installation, adjustments, alteration, service, or maintenance can cause personal injury or property damage. Refer to this manual.

This appliance operates as an unvented room heater when fitted to a solid fuel burning masonry fireplace or UL 127 approved factory built fireplace with the flue damper closed. It may also be installed in an approved unvented fireplace.

WARNING:

THIS IS AN UNVENTED GAS FIRED HEATER. IT USES AIR (OXYGEN) FROM THE ROOM IN WHICH IT IS INSTALLED. PROVISIONS FOR ADEQUATE COMBUSTION AND VENTILATION AIR MUST BE PROVIDED. REFERENCE FUEL GAS CODE NFPA 54, ANSI Z223.1 REFER TO PAGE 2 OF THE INSTALLATION INSTRUCTIONS.

This appliance is designed to supplement a current heating system. It is not designed to be used as a primary heat source.

NOTE:

This appliance is only for use with the type of gas indicated on the rating plate. This appliance is not convertible for use with other gases. Solid-fuels shall not be burned in a fireplace where a decorative appliance is installed.

IMPORTANT PRE-INSTALLATION AND FIREPLACE SAFETY INFORMATION

To determine the safest and most efficient location for your Vent Free Fireplace, you must take into consideration the following guidelines.

1. This appliance operates as an unvented room heater certified under ANSI Z21.11.2a when fitted to a masonry or factory built fireplace with the flue damper open or closed. It may also be installed in approved vent free fireplace. If installing in an approved vent free firebox, refer to their instruction guide for proper installation. Solid fuels shall not be burned in a fireplace where an unvented room heater is installed.
2. Do not use a natural gas set for propane or a propane set for natural gas. If the gas type is not correct. **DO NOT INSTALL.** Contact your dealer for immediate assistance. Any change to this heater or its controls can be dangerous.
3. Gas log sets must be installed by personnel qualified for installing gas appliances.
4. The location must allow for proper clearances for accessibility of servicing and proper operation (see section on Fireplace Clearances – page 4).
5. Consider a location where heat output would not be affected by drafts, air conditioning ducts, windows or doors. Do not allow fans to blow directly into the fireplace, avoid any drafts that alter burner flame patterns.
6. Inspect area surrounding the location chosen for the fireplace for possible air drafts that may affect the flames and possibly cause sooting. Air drafts may be caused by a ceiling fan near the fireplace, a hot furnace or an open door.
7. Due to high temperatures, the appliance should be located out of traffic and away from furniture and draperies. Young children should be carefully supervised when they are in the same room with the appliance. It is recommended that adults be present when this gas appliance is operating. It is recommended that this unit is not left burning when unattended or while anyone is sleeping.
8. Children and adults should be alerted to the hazards of high surface temperatures and should stay away to avoid burns or clothing ignition.
9. Install in an area providing adequate combustion and ventilation air (see section on adequate combustion and ventilation air requirements – page 3).
10. Do not install in a building that is of unusually tight construction. Unusually tight construction is defined as construction where:
 - a. Walls and ceiling exposed to the outside atmosphere have a continuous wall vapor retarder with a rating of 1 perm or less with openings gasketed or sealed, and
 - b. Weather stripping has been added on openable windows and doors, and
 - c. Caulking or sealants are applied to areas such as joints around window and door frames, between sole plates and floors, between wall-ceiling joints, between wall panels, at penetration for plumbing, electrical and gas lines and at other openings.
11. Do not install this heater in bedrooms, bathrooms or recreational vehicles.
12. This appliance may be installed in an aftermarket manufactured (mobile) home, where not prohibited by state or local codes.
13. Maintain adequate clearances around air openings.
14. When glass fireplace doors are used, always operate gas log set with the doors fully open to allow for proper combustion air and to keep control valves from overheating.
15. Keep appliance area clear and free from combustible materials, gasoline and other flammable vapors and liquids. Do not allow clothing or flammable materials on or near the fireplace. The flame in this appliance is not isolated from the air space it heats and it will ignite flammable vapors, dust particles or other combustible materials that come in contact with it which can result in an explosion or fire.

PRE-INSTALLATION REQUIREMENTS

COMBUSTION AND VENTILATION AIR REQUIREMENT WORKSHEET

WARNING: IF THE AREA IN WHICH THE HEATER MAY BE OPERATED IS SMALLER THAN THAT DEFINED AS UNCONFINED SPACE OR IF THE BUILDING IS OF UNUSUALLY TIGHT CONSTRUCTION, PROVIDE ADEQUATE COMBUSTION AND VENTILATION AIR BY ONE OF THE METHODS DESCRIBED IN THE NATIONAL FUEL GAS CODE, ANSI Z223.1 SECTION 5.3 OR APPLICABLE LOCAL CODES.

This heater shall not be installed in a confined space or unusually tight construction unless provisions are provided for adequate combustion and ventilation air.

The following formula can be used to determine the maximum BTU rating per the definition of unconfined space:

STEP ONE: DETERMINE THE VOLUME OF SPACE IN CUBIC FEET.

LENGTH X WIDTH X HEIGHT = _____ cu. Ft.
(Include adjoining rooms with doorless passageways or ventilation grills between rooms.)

Example: 24' (L) X 16' (W) X 8' (H) = 3,072. cu. Ft.

STEP TWO: MULTIPLY THE VOLUME OF SPACE BY 20 BTU/Hr. TO DETERMINE THE MAXIMUM BTU/Hr. THE SPACE CAN SUPPORT.

Example: 3,072 cu. Ft. X 20 BTU/Hr. = 61,440 BTU/Hr.
(Maximum BTU/Hr. the room can support)

STEP THREE: ADD THE BTU/Hr. OF ALL THE FUEL BURNING APPLIANCES IN THE SPACE.

VENT FREE HEATER _____ BTU/Hr.

GAS APPLIANCE #1 _____ BTU/Hr.

GAS APPLIANCE #2 _____ BTU/Hr.

Example: VENT FREE HEATER 26,000 BTU/Hr.
GAS APPLIANCE #1 35,000 BTU/Hr.
TOTAL 61,000 BTU/Hr.

NOTE: DO NOT INCLUDE DIRECT-VENT GAS APPLIANCES. DIRECT VENT IS SEALED COMBUSTION AND DRAWS COMBUSTION AIR FROM THE OUTDOORS.

THE SPACE IN THE ABOVE EXAMPLE IS AN UNCONFINED SPACE BECAUSE THE 61,000 BTU'S AN HOUR USAGE IS LESS THAN THE 61,440 BTU'S AN HOUR AVAILABLE. IF THE TOTAL BTU'S AN HOUR USAGE IS GREATER THAN 61,440 BTU'S AN HOUR THEN THE SPACE WOULD BE A CONFINED SPACE AND ADDITIONAL AIR MUST BE PROVIDED.

The National Fuel Gas Code defines a confined space as a space whose volume is less than 50 cubic feet per 1,000 BTU per hour (4.8 m³ per kw) of the aggregate input rating of all appliances installed in that space and unconfined space as a space whose volume is not less than 50 cubic feet per 1,000 BTU per hour (4.8 m³ per kw) of the aggregate input rating of all appliances installed in that space. Rooms communicating directly with the space in which the appliances are installed, through openings not furnished with doors, are considered a part of the unconfined space.

PRE-INSTALLATION SPECIFICATIONS

BTU RATINGS AND PRESSURE REQUIREMENTS

LOG SET SIZE	22" SETS		26" SETS	
GAS TYPE	Natural	Propane	Natural	Propane
MAX. HEAT INPUT	32,000 BTU	32,000 BTU	40,000 BTU	33,000 BTU
MIN. HEAT INPUT	24,000 BTU	23,500 BTU	29,000 BTU	23,500 BTU
GAS INLET PRESSURE				
MAX.	10.5" WC	13" WC	10.5" WC	13" WC
MIN.	5" WC	11" WC	5" WC	11" WC
REGULATOR PRESSURE	4" WC	10" WC	4" WC	10" WC

When operating the main burner, use the remote buttons to raise and lower the min. and max heat output. Hold the top button for max heat and the bottom button for min. heat.

Input ratings are shown in BTU per hour and are for elevations up to 2,000 feet. For elevations above 2,000 feet, input ratings should be reduced 4% for each 1,000 feet above sea level. Refer to the National Fuel Gas Code.

WARNING: OPERATION OF THIS APPLIANCE ON GASES FOR WHICH IT IS NOT EQUIPPED MAY LEAD TO CARBON MONOXIDE POISONING.

FIREPLACE DIMENSIONS AND CLEARANCES

Refer to the following charts to determine the proper size set for your fireplace.

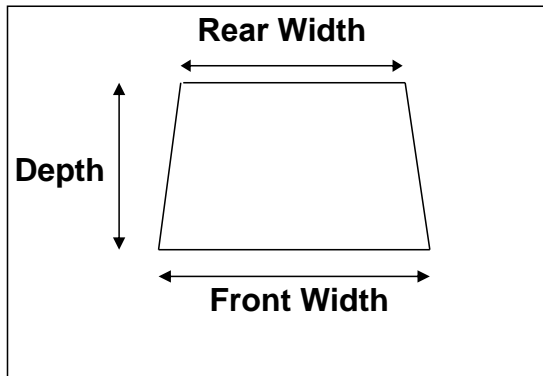

Minimum Fireplace Dimensions				
Log Set Size	Height	Front Width	*Rear Width	Depth
22"	16"	28"	23"	12"
26"	16"	30"	25"	12"

*At depth listed

PRE-INSTALLATION SPECIFICATIONS

MINIMUM CLEARANCES TO COMBUSTIBLE MATERIALS AND MANTLE CLEARANCES

IMPORTANT: To insure a safe installation into a masonry or factory built fireplace, the following instructions must be carefully observed. If installing in a pre-manufactured fireplace follow the clearance requirements accompanying that fireplace.

Refer to Fig. 1 for the following dimensions:

- A. Minimum left and right clearance to combustible walls = 15".
- B. Minimum clearance to combustible ceiling = 42".
- C. Minimum left and right side clearances to mantle = 6".

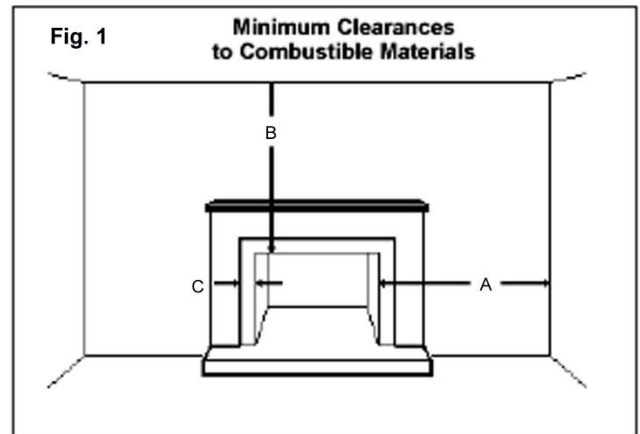

Note: Clearances to Combustible Materials and Mantle Clearances are in place to provide adequate spacing to prevent a fireplace mantle or facing from catching fire. In most cases they should also be adequate to prevent any discoloration or warping due to heat. However, each Gas Log installation will present unique circumstances creating many variables beyond the control of the Gas Log Manufacturer, including paint or finish composition, previous heat exposure, quality of construction, air flow patterns etc. Because of these variables we cannot guarantee that heat warping or discoloration will never occur. The possibility of heat damage exists whether burning wood or gas logs.

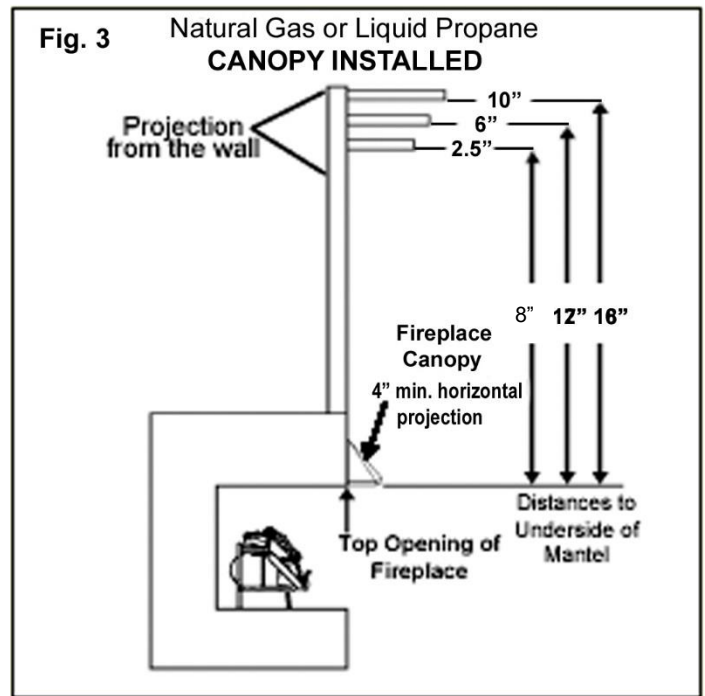
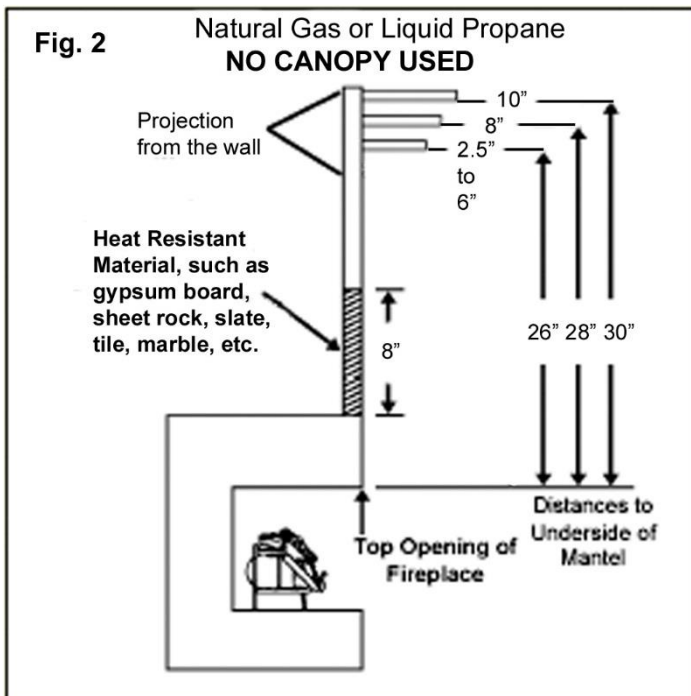

IMPORTANT: Woodwork such as mantles and other combustible material must be installed as tested per Fig 2 or Fig 3. Heat resistant material are materials such as gypsum board, sheetrock, slate, tile marble etc. If the mantle and wall are both non-combustible, mantle clearances are not applicable.

NOTE: A hood (canopy) as shown in Fig 3 is used to deflect heat away from the fireplace face and mantle, reducing the chances of heat damage or discoloration. If using a hood, it must project a minimum of 4" from the face of the firebox. Contact your dealer to purchase a fireplace hood.

PRE-INSTALLATION CHECKLIST

INSTALLER: Please leave these instructions with the homeowner.

HOMEOWNER: Please retain these instructions for future reference.

State or local codes may only allow operation of this unit in a vented application. Check your state and local codes.

All Hargrove vent free room heaters comply with IAS U.S. Requirement 5-95.

The installation must conform with state and local codes or, in absence of local codes, to the National Fuel Gas Code, ANSI Z223.1

FIREPLACE PREPARATION

IMPORTANT: Before installing in a solid fuel-burning fireplace, the chimney flue and firebox must be cleaned of soot, creosote, ashes, and loose paint by a qualified chimney cleaner.

1. Turn the gas supply to OFF.
2. Turn OFF all electrical power to blower (if applicable) before installing, servicing, or removing.
3. Clean the fireplace floor, walls, and chimney (if used) of any ashes, soot creosote, obstruction. *This will minimize any smell from the fireplace.* We recommend cleaning by a chimney sweep.
4. Any outside air ducts and/or ash dumps in the fireplace must be permanently closed at the time of appliance installation.
5. A mesh fireplace screen must be in place when the appliance is operating unless other provision for combustion air are provided, the screen shall have an opening(s) for introduction of combustion air.

This unit complies with 527 CMR 30.00 vent free appliance requirements for Massachusetts.

INSTALLATION

NOTE: Before you proceed, make sure your gas supply is OFF!

Check Gas Type: The gas supply must be the same as stated on the heater's rating plate. If the gas supply is different, DO NOT INSTALL the heater. Contact your dealer for the correct model.

IMPORTANT: This appliance cannot be used with or converted to a gas other than the type for which it was equipped at the factory.

WARNING: OPERATION OF THIS APPLIANCE ON GASES FOR WHICH IT IS NOT EQUIPPED MAY LEAD TO CARBON MONOXIDE POISONING.

This product must be installed by a licensed plumber or gasfitter when installed within the Commonwealth of Massachusetts.

WARNING: CONNECTING DIRECTLY TO AN UN-REGULATED L.P. TANK CAN CAUSE AN EXPLOSION.

GAS CONNECTION

WARNING: ANY MODIFICATION TO THIS UNVENTED GAS HEATER OR ITS CONTROLS CAN BE DANGEROUS. IMPROPER INSTALLATION OR USE OF THE HEATER CAN CAUSE SERIOUS INJURY OR DEATH FROM FIRE, BURNS, EXPLOSION OR CARBON MONOXIDE POISONING.

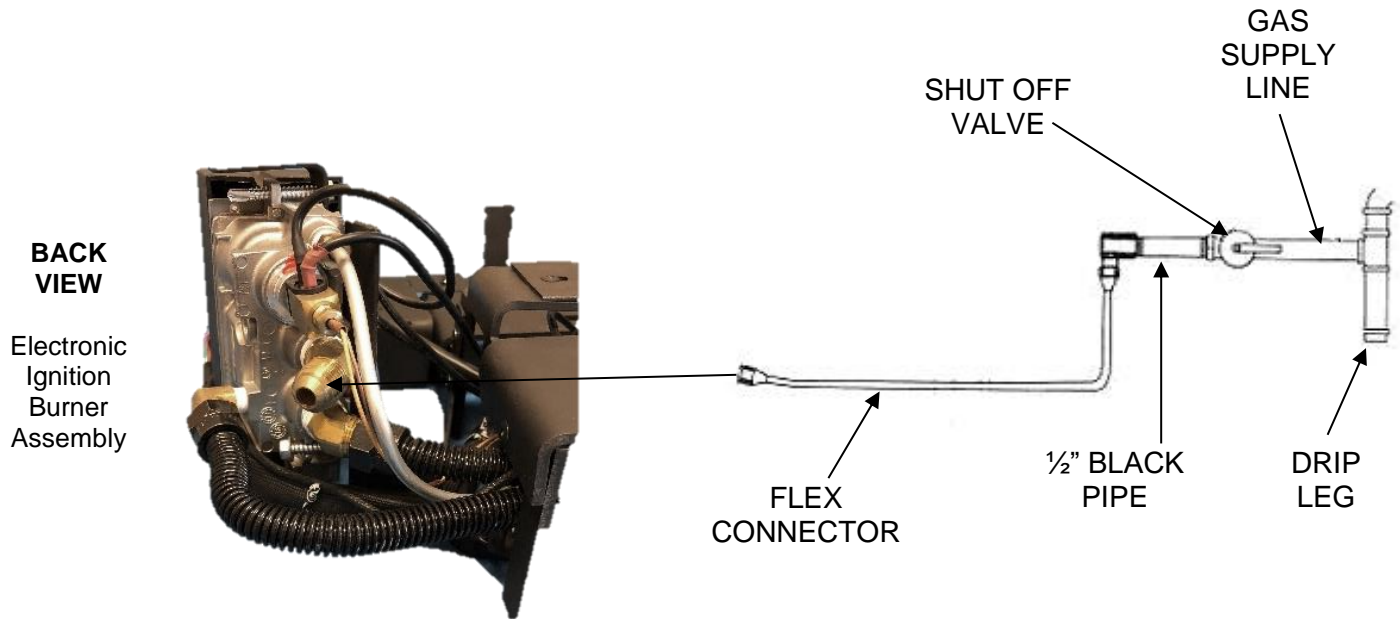

IMPORTANT STEPS TO FOLLOW WHEN MAKING THE GAS LINE CONNECTION

1. Consult your gas supplier for proper gas pipe sizing. Normally up to 50' of 1/2" inside diameter (ID) gas pipe will supply adequate volume for all vent free units.
2. The incoming gas line may be routed into the fireplace either from the left or right side.
3. Include a manual shutoff valve in the gas supply line so the appliance may be disconnected for servicing.
4. Center the burner system from side to side in the firebox. In a vented firebox, if the damper is used, the burner assembly should be located directly under the damper.
5. Use the 3/8" flex connector (provided in the accessory kit) to connect the gas supply line to the point shown above on the burner assembly.
6. Always use an external regulator for all L.P. appliances to reduce the supply tank pressure to a maximum of 13" W.C. This is in addition to the regulator inside the valve.
7. Test all connections after turning gas supply on for leaks using a soap and water solution. **DO NOT USE AN OPEN FLAME FOR LEAK TESTING.**
8. It is most convenient to light the pilot and check the operation of the main burner with the logs not in place. After carefully checking the gas supply line for leaks and correcting any found, refer to the "LIGHTING INSTRUCTIONS" section to test the burner assembly.

WARNING: DO NOT USE A BLOWER INSERT, HEAT EXCHANGER INSERT OR OTHER ACCESSORY NOT APPROVED FOR USE WITH THIS HEATER.

GAS PRESSURE CHECK

NOTE: The appliance and the appliance main gas valve must be disconnected from the gas supply system during any pressure testing of that system at test pressures in excess of 0.5 psig (3.5 kPa). The appliance must be isolated from the gas supply piping system by closing its equipment shut-off valve during any pressure testing of the gas supply piping system at test pressures equal to or less than 0.5 psig (3.5 kPa).

1. The gas valve controls the gas pressure, which can be checked at the pressure test point located at the bottom of the valve.
2. The pressure should be checked with the heater burner and the control set to high (HI).
3. The pressure is preset and locked to avoid tampering. If the pressure is not as specified in “BTU Rating and Pressure Requirements” (pg. 3), contact your dealer.
4. Replace the test plug after measuring gas pressure. Check for gas leaks.

IMPORTANT: Do not use the appliance if any part has been submerged under water. Immediately call a qualified technician to inspect the appliance and to replace any part of the control system and any gas control which has been under water.

VALVE POSITION CHECK

Ensure that the spacing between the valve and receiver bracket (1) is enough for the valve's bottom knob to spin freely. Also, be sure that the switch (2) is switched to the on position and the top knob (3) is spun in the counter clockwise direction.

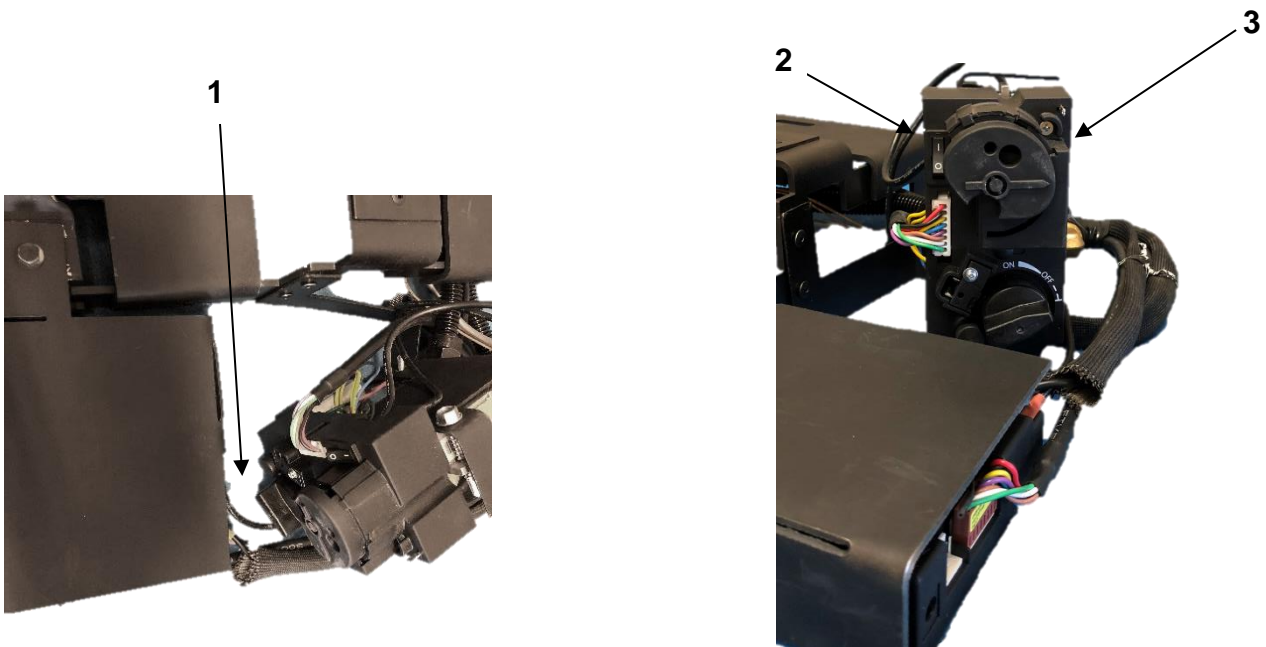

LOG INSTALLATION

HIGHLAND GLOW 22"/26"

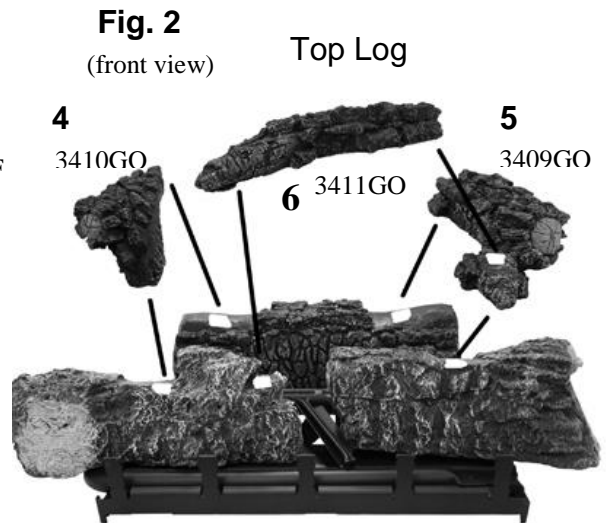
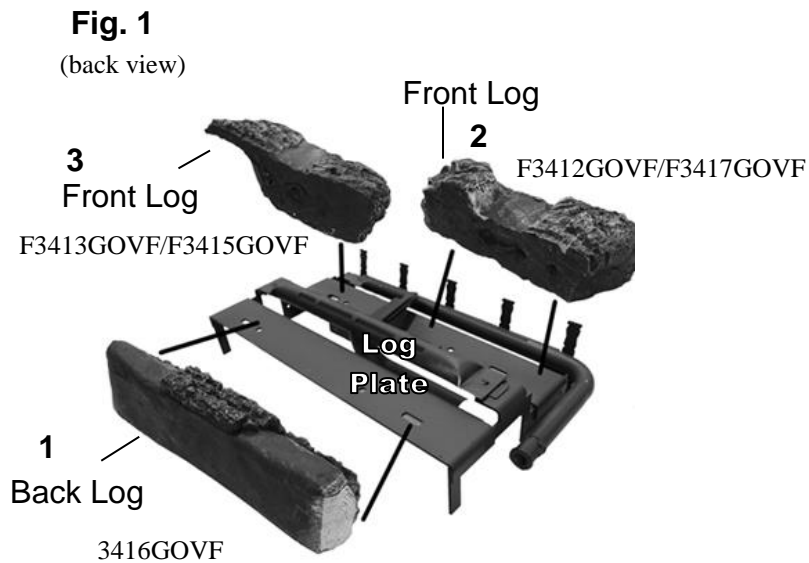

Step 1 – Identify each of the 6 logs in the set by comparing them to the log pictures above. (Fig 1 & 2)

Step 2 – Identify the Back Log Plate in the log box. (Fig 1)

Step 3 – Install the Log Plate on the Back Burner Plate by placing the tabs on the bottom of the Log Plate in the holes on the Back Burner Plate. Assure that the tabs on the Log Plate are facing forward toward the grate on the front of the set.

Step 4 – Place the Back log (1) on the Log plate with the char area facing forward.

Step 5 - Install the Front Logs (2 & 3) by placing the locator pins on the bottom of each log in the holes on the Front Burner Plate. (Fig 1)

Step 6 – Install the left Top Log (4) by placing the flat side of the log on the notches on the top of the back and front log. The branch should be facing forward. (Fig 1 & 2)

Step 7 – Install the right Top Log (5) by placing the flat side of the log on the notches on the top side of the back and front log. The branch should be facing forward. (Fig 1 & 2)

Step 8 – Install the middle Top Log (6) with the charred end resting in the notch on the top of the Front Left Log and the other end resting on the front flat area of the right Top Log.

Step 9 – Assure that all of the logs have at least a 1" clearance around the burner ports of the Back Burner (Fig 3).

Step 10 – Once the set is completely set up, observe the operation of the set. **The back flame should not be coming in contact with any logs.** The front flame should cause a glowing effect on the ember material and part of the surface of the front logs (Fig 4).

Fig. 3

TOP VIEW

Keep a minimum 1" Clearance around burner ports on the Back Burner.

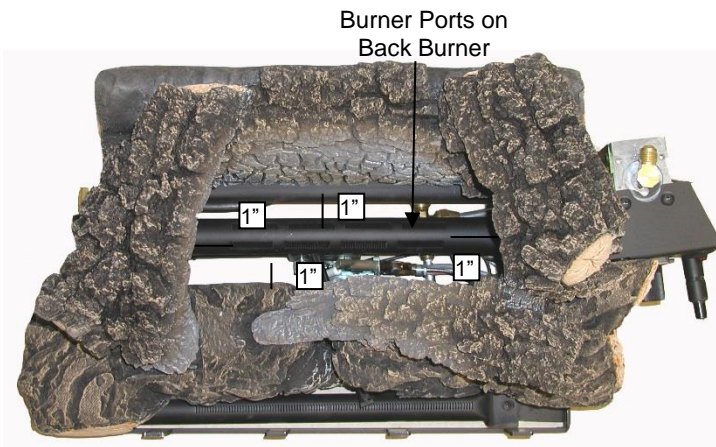
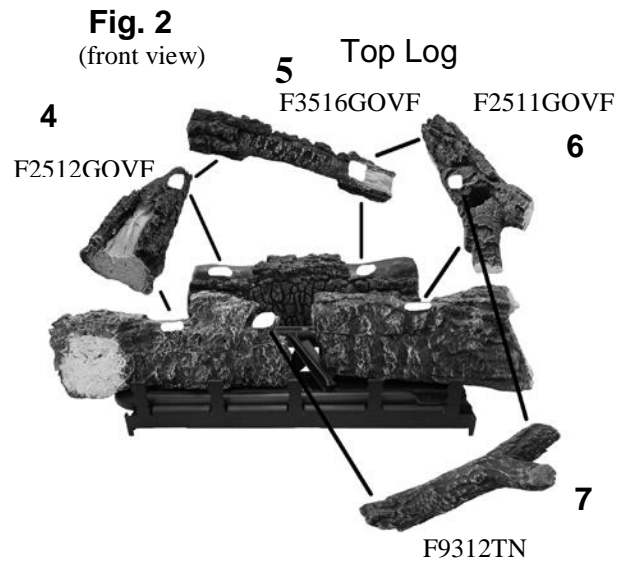
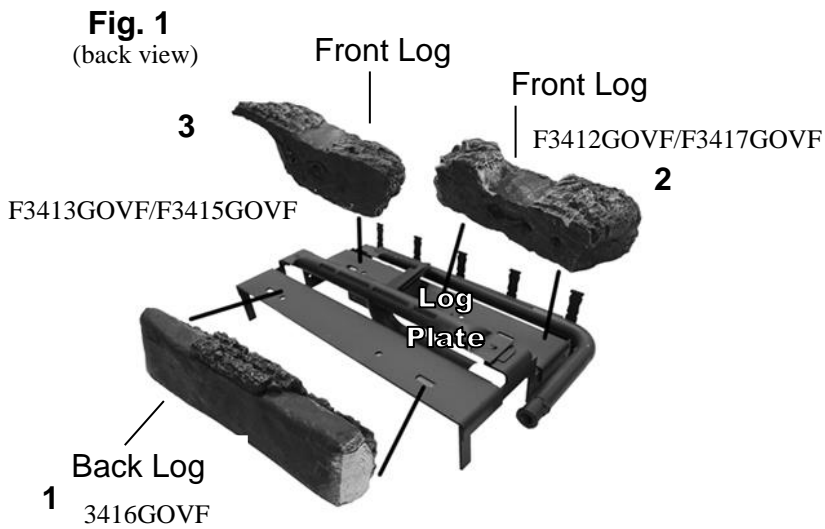

Fig. 4



LOG INSTALLATION

CHARLESTON GLOW 22"/26"



Step 1 – Identify each of the 7 logs in the set by comparing them to the log pictures above. (Fig 1 & 2)

Step 2 – Identify the Back Log Plate in the log box. (Fig 1)

Step 3 – Install the Log Plate on the Back Burner Plate by placing the tabs on the bottom of the Log Plate in the holes on the Back Burner Plate. Assure that the tabs on the Log Plate are facing forward toward the grate on the front of the set.

Step 4 – Place the Back log (1) on the Log plate with the char area facing forward.

Step 5 – Install the Front Logs (2 & 3) by placing the locator pins on the bottom of each log in the holes on the Front Burner Plate. (Fig 1)

Step 6 – Install the left Top Log (4) by placing the flat side of the log on the notches on the top of the back and front log. (Fig 2)

Step 7 – Install the back Top Log (5) by placing the flat side of the log on the notches on the right side on the back log and the left side on the flat side of the left top log. (Fig 2)

Step 8 – Install the right Top Log (6) with the charred end resting in the notch on the top of the Front Left Log and the other end resting on the front flat area of the back Top Log. (Fig 2)

Step 9 – Install the front Top Log (7) by placing the left side in the notch of the front left log and the right side on the flat spot of the right Top log. (Fig 2)

Step 10 – Assure that all of the logs have at least a 1" clearance around the burner ports of the Back Burner (Fig 3).

Step 11 – Once the set is completely set up, observe the operation of the set. **The back flame should not be coming in contact with any logs.** The front flame should cause a glowing effect on the ember material and part of the surface of the front logs (Fig 4).

Fig. 3

TOP VIEW

Keep a minimum 1" Clearance around burner ports on the Back Burner.

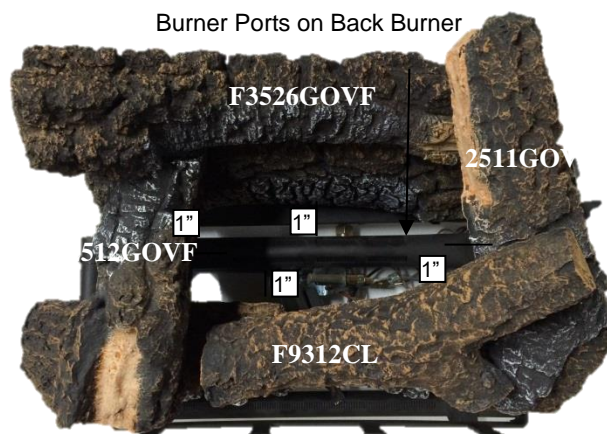

Fig. 4



EMBER PLACEMENT

WARNING: IMPROPER INSTALLATION OF THE EMBER MATERIAL MAY LEAD TO CARBON MONOXIDE POISONING.

EMBER PIECE

Fig. 1



Actual
Size

Fig. 2



Front Grate

Front Burner/Burner Ports

1. Tear the Ember Material into 10 to 12 individual pieces (Fig 1).
2. Slightly stretch each Ember piece so it can be placed on the front burner ports and be supported by the front grate and burner (Fig. 1 & 2).
3. Place the pieces of Ember Material evenly across the front burner so as many front burner ports can be covered as possible. (Fig 3 & 4)

DO NOT PRESS THE EMBER MATERIAL INTO THE BURNER PORTS.

4. You may place some ember material on the tube that connects the front and back burner. Do not press the ember material into the ports as it may obstruct the ignition of the front burner.

DO NOT PLACE ANY EMBER MATERIAL ON THE BACK BURNER (Fig. 3)

Fig. 3

DO NOT PLACE ANY EMBER MATERIAL ON BACK



Fig. 4

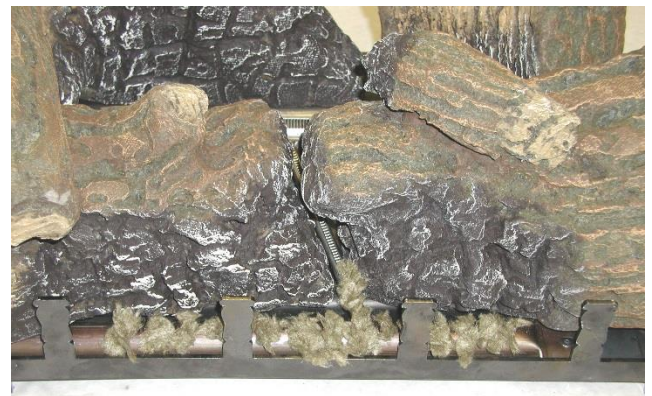

Front Burner with Embers Properly Installed

WARNING: DO NOT PUT ANY ADDITIONAL EMBER MATERIAL ON THE BURNER SYSTEM. USE ONLY WHAT WAS PROVIDED WITH THE SET.
PLACING ADDITIONAL EMBER MATERIAL ON THE SET MAY CAUSE IMPROPER COMBUSTION AND WILL VOID THE MANUFACTURER'S WARRANTY.

VOLCANIC CINDER PLACEMENT

The Volcanic Cinder is the large bag of black rock that is included in the log set. The purpose of it is to cover the fireplace floor surrounding the set. The Volcanic Cinder will also cover the metal Lighting Instruction tags and help keep them out of sight.



You may use the Volcanic Cinder to cover up the metal Lighting Instruction tags.

VOLCANIC CINDER

FRONT OF GRATE

You may use the Volcanic Cinder to cover the horizontal portion of the Front of the Grate.

1. Once the burner system is in place, pour the Volcanic Cinder on the floor of the fireplace. **DO NOT POUR ANY VOLCANIC CINDER ON THE BURNERS OR AROUND THE PILOT.**
2. You may use the Volcanic Cinder to cover up the Lighting Tags that are attached to the set. **DO NOT REMOVE THE LIGHTING TAGS FROM THE BURNER SYSTEM. THIS WILL VOID THE MANUFACTURER'S WARRANTY.**
3. You may use the Volcanic Cinder to cover the horizontal portion of the front of the grate. **DO NOT POUR VOLCANIC CINDER ON THE BURNER OR AROUND THE PILOT.**

WARNING: GLASS DOORS MUST BE OPEN WHEN APPLIANCE IS IN OPERATION.

RECEIVER CONCEALMENT



To hide the receiver, place the 2508 on top of the receiver bracket so that the front of the log hangs off the front of the bracket covering the front.

OPERATION

FOR YOUR SAFETY READ BEFORE LIGHTING

⚠ WARNING: If you do not follow these instructions exactly, a fire or explosion may result causing property damage, personal injury or loss of life.

A. **BEFORE LIGHTING** smell all around the appliance area for gas. Be sure to smell next to the floor because some gas is heavier than air and will settle on the floor.

WHAT TO DO IF YOU SMELL GAS

- Do not try to light any appliance.
- Do not touch any electrical switch.
- Do not use any phone in your building.
- Immediately call your gas supplier from a neighbor's phone. Follow the gas supplier's instructions.
- If you can not reach your gas supplier, call the fire department.

B. Use only your hand to push in or turn the gas control knob. Never use tools. If the knob will not push in or turn by hand, don't try to repair it, call a qualified service technician. Force or attempted repair may result in a fire or explosion.

C. Do not use this appliance if any part has been under water. Immediately call a qualified service technician to inspect the appliance and to replace any part of the control system and any gas control which has been under water.



LIGHTING INSTRUCTIONS

1. STOP! Read the safety information above on this page.
2. Open bottom louver assembly, (if applicable).
3. Press the "I/O" (ON/OFF) button on the valve to face to "O" (OFF).
4. Wait five (5) minutes to clear out any gas, then smell for gas including near the floor. If you smell gas, STOP! Follow "A" in the safety information above. If you don't smell gas, go to the next step.

LIGHTING PROCEDURE - HANDSET METHOD

1. Turn control arrow on valve face to "ON." Press the "I/O" button to "I". Press the "OFF" and "UP" buttons on the handset firmly at the same time. A long "beep" will sound, followed by 5 short "beeps". Ignitor will spark and will continue until pilot is lit. For full Remote Control operation see appliance installation manual.

LIGHTING PROCEDURE - MANUAL METHOD

1. Press the "I/O" (ON/OFF) button to "I" for on.
2. Turn control arrow on valve face to "MAN" for manual.
3. Change the ignition cable from the receiver to the valve (Piezo Ignition tab).
4. Using a small bladed screwdriver, press & hold button within hole on control. Manually depress piezo igniter button to light the pilot. If pilot does not light, step 4 can be immediately repeated. If the pilot will not stay lit after several tries, follow the instructions "To Turn Off Gas to Appliance" and call your service technician or gas supplier.
5. When the pilot is lit and stable, turn the valve control knob counterclockwise  to the "ON" position. Turn flame height control knob counterclockwise  and the main burner will ignite. Turn flame height control knob to adjust flame height.

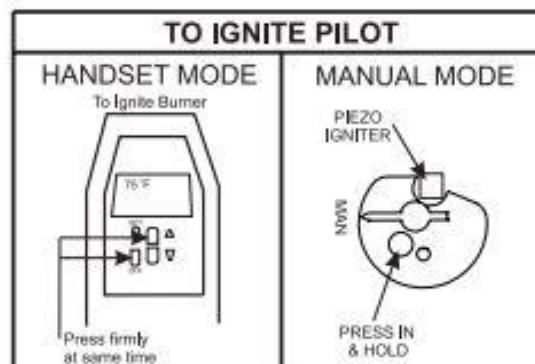
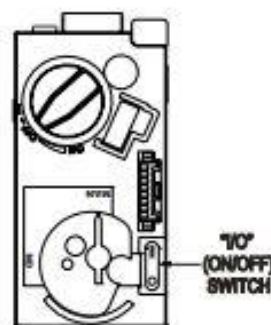

TO TURN OFF GAS TO THE APPLIANCE

MANUAL MODE - To turn off main burner, turn flame height control knob fully clockwise . To fully shut down, press "I/O" button to "O".

HANDSET MODE - Press "OFF" button on handset. To fully shut down, press "I/O" button to "O".

OPERATION

TO TURN OFF GAS TO APPLIANCE

SHUT-DOWN PROCEDURE:

Press the off button on the remote.

Controlling Heat Output

* The heat output can be controlled by pressing the top or bottom buttons on the remote.

* Another way to regulate the heat output is to open the fireplace damper.

If you want:

- a. more heat radiated into the room – Keep the damper completely closed
- b. less heat radiated into the room – open the fireplace damper to varying degrees.

Important Safeguards

1. To avoid personal injury, do not touch hot surfaces when the appliance is operating.

Hot Surfaces

- a. Grate
- b. Burner
- c. Logs
- d. Surfaces above the opening of the fireplace

2. Although your gas logs are very realistic in appearance, it is not a real wood-burning fireplace and must not be used for burning any material.

* To avoid irreparable damage to the appliance or personal injury, matches, paper, garbage, or any other material must not be placed or thrown on top of the logs or into the flames.

Close supervision is necessary when the appliance is being operated near children.

Avoid any drafts that alter burner patterns. Do not allow fans to blow directly into the fireplace. Ceiling fans may create drafts that alter burner flame patterns. Sooting and improper burning will occur.

Cleaning And Servicing

Installation and repair should be done by a qualified service person. The appliance should be inspected before use and at least annually by a professional service person. More frequent cleaning may be required due to excessive lint from carpeting, bedding, and material, etc. It is imperative that control components, burners and circulating air passageways of the appliance be kept clean.

- If the flames show any unusual shapes or behavior, or the burners fail to ignite properly, then the burner holes may require cleaning.

WARNING: TURN OFF VENT FREE BURNER SYSTEM AND ALLOW TO COOL BEFORE CLEANING OR SERVICING.

MONTHLY CLEANING

1. If removing logs, when reinstalling, refer to “Log Assembly Diagram” for correct log placement.
2. Do not use cleaning fluids to clean logs or any part of the heater.
3. Brush logs with a soft bristle brush or vacuum with brush attachment.
4. Vacuum loose particles and dust from the front and rear burner ports, gas control, piezo cover, and grate.
5. Inspect and clean ODS pilot for operation and accumulation of lint at air intake holes.
6. Verify flame pattern and log placement for proper operation.
7. Verify smooth and responsive ignition of main burner and rear burner. Refer to page for proper pictorial sketch of proper operation.

ANNUAL CLEANING AND INSPECTION

1. Dealer or qualified inspector – follow the above steps for proper servicing and inspection.

PARTS AND ASSEMBLY IDENTIFICATION

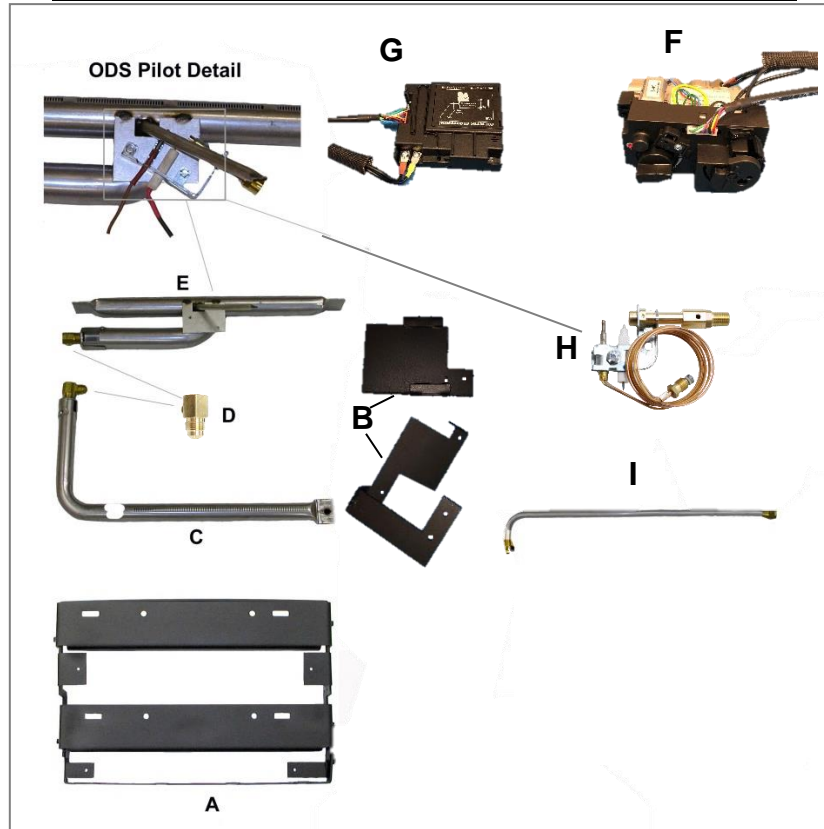

Electronic Ignition Vent Free Burner Assembly



ITEM	DESCRIPTION	QTY	EF(TG,HG)22(N,P)3E	EF(TG,HG)26(N,P)3E
A.	TG BURNER ASSEMBLY	1	TGBA-22	TGBA-26
B.	MEI VALVE BRACKETS (3E)	1	TGMAXUB	TGMAXUB
C.	FRONT BURNER	1	TBF-22	TBF-26
D.	BRASS ORIFICE	2	46-6-6	46-6-6
E.	BACK BURNER	1	TBB-22	TBB-26
F.	MEI VALVE	1	MEI-V-(NG,LP)-VF	MEI-V-(NG,LP)-VF
G.	MEI RECEIVER	1	MERI-REC	MERI-REC
H.	OXYGEN DEPLETION SENSOR (NG)	1	OP-8203-005-NG	OP-8203-005-NG
	OXYGEN DEPLETION SENSOR (LP)	1	OP-8403-005-LP	OP-8403-005-LP
I.	FLEX CONNECTOR	3	FC-16B	FC-16B

GV60

Remote Electronic Ignition and Control System



ENGLISH - INSTALLATION AND OPERATING INSTRUCTIONS



FC CE 0085



Precision Engineering for Multiple Markets

MERTIK MAXITROL®
Exclusive Distributor for Maxitrol Company

IMPORTANT SAFETY INFORMATION	2
OPERATING INSTRUCTIONS	
General Notes	3
Setting the Electronic Code.....	3
To turn ON Appliance	4
To turn OFF Appliance	4
Flame Height Adjustment	4
To open and close Solenoid Valve/Burner	5
Light/Dimmer Operation	5
Circulating Fan Operation	5
Modes of Operation	6
Setting °C/24 Hour or °F/12 Hour Clock	6
Setting the Time	6
Setting the ON/OFF Temperatures	7
Setting Program Timers	7
Manual Operation	8
Turn OFF Gas to Appliance	9
Automatic Turn Down	9
Automatic Shut Off	9

IMPORTANT SAFETY INFORMATION

▲ WARNING

Fire or explosion hazard. Read these instructions carefully. Failure to follow them could result in a fire or explosion causing property damage, personal injury, or loss of life. The product must be installed and operated according to all codes and local regulations.

Damper position must be in accordance with Manufacturer's Installation Instructions and all applicable Standards. Failure to follow these Instructions and/ or Standards may cause property damage, personal injury, or loss of life.

Do not store or use gasoline or other flammable vapors and liquids in the vicinity of this control or other appliances.

WHAT TO DO IF YOU SMELL GAS

- Do not operate any appliance.
- Do not touch any electrical switch; do not use any phone in your building.
- Immediately evacuate the area and contact the gas supplier. Follow the gas supplier's instructions.
- If you cannot reach the gas supplier, call the fire department.

Installation and service must be performed by a qualified installer, service agency, or the gas supplier. Installation shall conform with local codes, or in the absence of local codes, in accordance with the National Fuel Gas Code ANSI Z223.1/NFPA 54 or the IFGC or CSA B149.1. All piping and tubing must comply with local codes and ordinances.

Use only your hand to push in or turn the gas control knobs. Never use tools. If a knob will not push in or turn by hand, do not try to repair it. Call a qualified service technician. Force or attempted repair can result in a fire or explosion.

Do **NOT** use this control or any gas appliance if any part has been under water or in contact with water. Immediately call a qualified service technician to replace the control system and any gas control that has been under water or in contact with water.

▲ WARNING

ELECTRIC SHOCK HAZARD

- Read these instructions carefully. Failure to follow them could result in property damage, personal injury, or loss of life.
- This control must be electrically wired and operated in accordance with all codes and local regulations. Service and installation must be performed by a trained, experienced service technician.
- Do not use the control if you suspect it may be damaged.

GENERAL NOTES

Radio Frequency Handset

433.92 MHz for Europe; 315 MHz for U.S. (FCC ID: RTD-G6R) and for Canada (IC: 4943A-G6R).

This device complies with part 15 of the FCC Rules. Operation is subject to the following two conditions: (1) This device may not cause harmful interference, and (2) This device must accept any interference received, including interference that may cause undesired operation. Changes or modifications not expressly approved by the party responsible for compliance could void the user's authority to operate the equipment.

NOTICE

Wiring of valve and receiver must be completed before starting ignition. Failure to do so could damage the electronics.

Batteries – Handset

- 1 x 9V (quality alkaline recommended).
- Low battery indicator on handsets with display.
- Handsets without display: the red LED gets darker.
- Battery replacement is recommended after 2 years.

Batteries – Receiver

- 4 x 1.5V "AA" (quality alkaline recommended).
- Low battery indication: frequent beeps for 3 seconds when motor turns.
- An AC Mains Adapter may be used instead of batteries.

NOTICE

Only the Mertik Maxitrol AC Mains Adapter or one preapproved by Mertik Maxitrol can be used. Use of other adaptors can render the system inoperable.

- The module for fan speed control and light/dimmer includes mains power together with batteries in the receiver for automatic backup in case of power outage.
- Without using a mains adapter, battery replacement is recommended at the beginning of each heating season.

NOTICE

The handsets, receivers, wall switches, switch panels and touch pads are not interchangeable with previous electronics (see figure 21).



Figure 21: Previous Handset

NOTICE

Replacement handsets for CSA models also must have the same part number (see label).

SETTING THE ELECTRONICS CODE

(First time use only.)

Radio Frequency Handset

A code is selected automatically for all Mertik Maxitrol electronics from among 65,000 random codes available. The receiver has to learn the code of the handset:

- Press and hold the receiver's reset button (see figure 22) until you hear two (2) beeps. The first beep is short and the second beep is long. After the second beep, release the reset button.
- Within the subsequent 20 seconds press the \downarrow (small flame) button on the handset until you hear two additional short beeps confirming the code is set. If you hear one long beep, this indicates the code learning sequence has failed or the wiring is incorrect.

NOTE: This is a one time setting only, and is not required after changing the batteries of the handset or receiver.



Figure 22: Receiver Reset Button

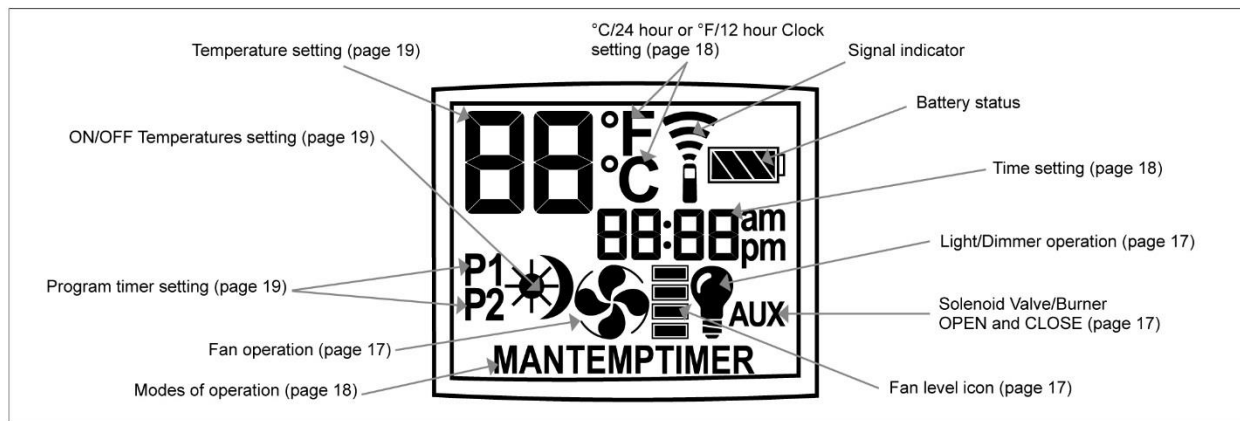

Figure 20

TO TURN ON APPLIANCE

▲ WARNING

When pilot ignition is confirmed, motor turns automatically to maximum flame height.

- Turn MANUAL knob to the **ON**, full counterclockwise position.
- Place ON/OFF switch (if equipped) in **I (ON)** position.

Handset



- Simultaneously press the OFF and 🔥 (large flame) buttons until a short beep confirms the start sequence has begun; release buttons.
- Continuing beeps confirm the ignition is in process.
- Once pilot ignition is confirmed, there is main gas flow.
- After main burner ignition the handset will automatically go into manual mode (CSA version, CE version).

Wall Switch/ Touch Pad/ Switch Panel

- Press button "B" (see figure 23) until a short beep confirms the start sequence has begun; release button.
- Continuing beeps confirm the ignition is in process.
- Once pilot ignition is confirmed, there is main gas flow.

▲ WARNING

If the pilot does not stay lit after several tries, turn the main valve knob to **OFF** and follow the instructions "TURN OFF GAS TO APPLIANCE" (page 21).

STANDBY MODE (Pilot Flame)

Handset

- Press and hold 🔥 (small flame) to set appliance at pilot flame.

Wall Switch/ Touch Pad/ Switch Panel

- Press and hold button "C" (see figure 23) to set appliance at pilot flame.

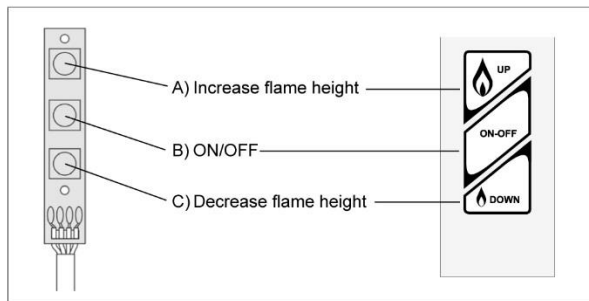
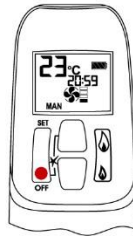

Figure 23: Switch Panel and Wall Switch/Touch Pad

TO TURN OFF APPLIANCE



Handset

- Press **OFF** button.

Wall Switch/ Touch Pad/ Switch Panel

- Press button "B" (see figure 23).

FLAME HEIGHT ADJUSTMENT

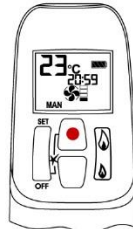

Handset

- In standby mode: Press and hold 🔥 (large flame) button to increase flame height.

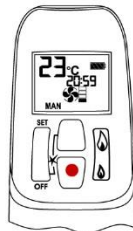

- Press and hold 🔥 (small flame) button to decrease flame height or to set appliance at pilot flame.
- For fine adjustment tap the 🔥 (large flame) or 🔥 (small flame) buttons.

Wall Switch/Touch Pad/Switch Panel

(See figure 23)

- Press and hold button "A" to increase flame height.
- Press and hold button "C" to decrease flame height or to set appliance at pilot flame.
- For fine adjustment tap button "A" or "C".

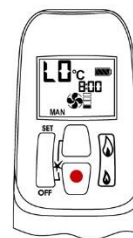

Designated Low Fire and High Fire

- Double-click 🔥 (small flame) button. "LO" will be displayed.

NOTE: Flame goes to high fire first before going to designated low fire.

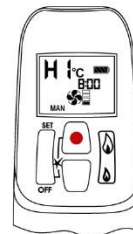

- Double-click 🔥 (large flame) button. Flame automatically goes to high fire. "HI" will be displayed.

▲ WARNING

If the appliance will not operate, follow the instructions "TURN OFF GAS TO APPLIANCE" (page 21).

TO OPEN AND CLOSE SOLENOID VALVE/BURNER

NOTE: The latching solenoid valve cannot operate manually. If the battery runs down it will remain in the last operating position. During normal operation the solenoid valve will be reset to the ON position when the GV60 is switched OFF remotely.



Burner OFF

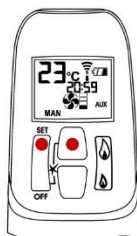

Burner ON

- Upon ignition Main Burner and Decorative Burner are ON.
- Simultaneously press SET and 🔥 (small flame) buttons to switch the Burner OFF. Printed instructions are on the battery cover (see figure 24).
- Simultaneously press SET and 🔥 (large flame) buttons to switch Burner ON. (The AUX symbol on the display indicates the solenoid valve is OPEN.)

NOTE: The operation of the AUX is blocked in timer OFF mode, when the setting of the 🌙 Nighttime Setback Temperature is "--".



Figure 24: Instructions for Latching Solenoid Valve (on battery cover)

LIGHT/DIMMER OPERATION

💡 – Light/Dimmer



- Briefly press SET button to scroll to 💡 (light bulb) mode. Light bulb icon flashes.
- Press and hold 🔥 (large flame) button to turn ON the light or increase brightness.
- Press and hold 🔥 (small flame) button to decrease brightness.
- In the Light/Dimmer mode, the OFF button shuts OFF the light.
- If you want the light ON but no flame, press and hold the 🔥 (small flame) button and turn to Pilot flame.

NOTE: The light bulb icon is displayed during light/dimmer setting only. 8 seconds after the light/dimmer has been set, the handset will automatically go into temperature control mode (CSA version) or manual mode (CE version).

CIRCULATING FAN OPERATION

🌀 – Circulating Fan

The circulating fan has 4 speed levels from low (1 bar) to high (4 bars).

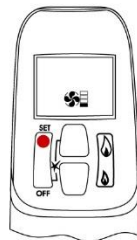

- Briefly press SET button to scroll to 🌀 (fan) mode. Fan and Level icons flash.
- Press 🔥 (large flame) button to switch ON and increase fan speed.
- Press 🔥 (small flame) button to decrease fan speed. To turn OFF fan, press 🔥 (small flame) button until all 4 speed level bars disappear.

NOTE: 8 seconds after the fan has been set, the handset will automatically go into temperature control mode (CSA version) or manual mode (CE version). The fan starts 4 minutes after the gas opens (from OFF or from pilot) at maximum speed and goes to the displayed level after 10 seconds. The fan stops 10 minutes after the gas is OFF or at pilot.

MODES OF OPERATION



- Briefly pressing the SET button changes the mode of operation in the following order:

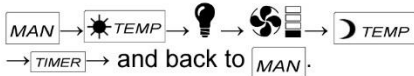

NOTE: Manual mode can also be reached by pressing either the (large flame) or the (small flame) button.



- **MAN** – **Manual Mode**
Manual flame height adjustment.

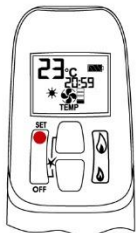

- ***TEMP** – **Daytime Temperature Mode**
(Appliance must be in standby mode; pilot ignited)
The room temperature is measured and compared to the set temperature. The flame height is then automatically adjusted to achieve the Daytime Set Temperature.



- **Light icon** – **Light/Dimmer Setting Mode**
Turns light/dimmer ON and OFF and adjusts brightness.

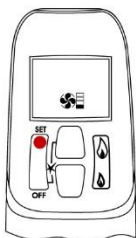

- **Fan icon** – **Circulating Fan Setting Mode**
Turns circulating fan ON and OFF and adjusts fan speed.

NOTE: To turn OFF fan press (small flame) until all 4 speed level bars disappear.



- **◐TEMP** – **Nighttime Setback Temperature Mode** (Appliance must be in standby mode; pilot ignited)
The room temperature is measured and compared to the Nighttime Setback Temperature. The flame height is then automatically adjusted to achieve the Nighttime Setback Temperature.

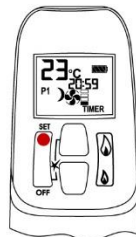

- **TIMER** – **Timer Mode** (Appliance must be in standby mode; pilot ignited)
The Timers P1 and P2 (Program 1, Program 2) each can be programmed to go ON and OFF at specific times. For instructions see Timer Programming Mode.

NOTE: The display shows the set temperature every 30 seconds.

SETTING °C/24 HOUR OR °F/12 HOUR CLOCK

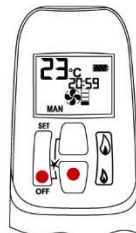

- Press **OFF** and (small flame) button until display changes from Fahrenheit/12 hour clock to Celsius/24 hour clock and vice versa.

SETTING THE TIME

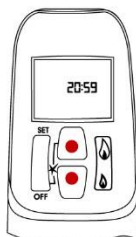

- The Time display will flash after either:
a) Installing the battery or
b) Simultaneously pressing the (large flame) and (small flame) buttons.
- Press (large flame) button to set the hour.
- Press (small flame) button to set the minute.
- Press **OFF** or simply wait to return to manual mode.

SETTING THE ON/OFF TEMPERATURES

Setting the “DAYTIME” Temperature

DEFAULT SETTINGS: TEMP (sun), 23 °C/74 °F



- Briefly press SET button to scroll to TEMP TEMP (sun) mode. Hold the SET button until the TEMP flashes.



- Press (large flame) button to increase Daytime Set Temperature.

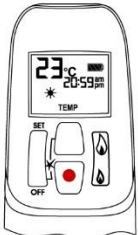

- Press (small flame) button to decrease Daytime Set Temperature.



- Press OFF or simply wait to complete programming.

Setting the “NIGHTTIME SETBACK” Temperature

DEFAULT SETTINGS: TEMP (moon), “--” (OFF)

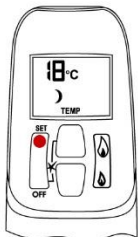

- Briefly press SET button to scroll to TEMP TEMP (moon) mode. Hold the SET button until the TEMP flashes.

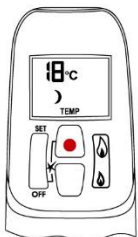

- Press (large flame) button to increase Nighttime Setback Temperature.

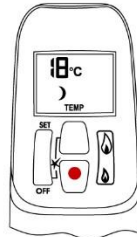

- Press (small flame) button to decrease Nighttime Setback Temperature.



- Press OFF or simply wait to complete programming.

SETTING PROGRAM TIMERS

Default Settings

CE: Program 1: P1 6:00 P1 8:00

Program 2: P2 23:50 P2 23:50

CSA: Program 1: P1 6:00^{am} P1 8:00^{am}

Program 2: P2 11:50^{pm} P2 11:50^{pm}

- 2 ON times can be programmed per day.
- CE: The day starts at 0:00, ends at 23:50.
- CSA: The day starts at 12:00^{am}, ends at 11:50^{pm}.
- The ON/OFF times have to be programmed in the order P1 ≤ P1 < P2 ≤ P2 .
- If P1 = P1 or P2 = P2 the timer is deactivated.
- To have the fire over night, it can be set:
CE: P2 23:50 and P1 0:00
CSA: P2 11:50^{am} and P1 12:00^{am}



- Select Timer Mode by briefly pressing the SET button.

Setting P1 ON Time

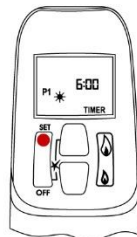

- Hold the SET button until P1 (sun) is displayed and the time flashes.

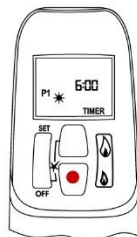

- Set the hour by pressing the (large flame) button.

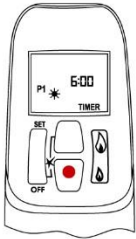

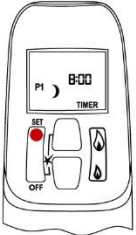

- Set the minutes by pressing the  (small flame) button.



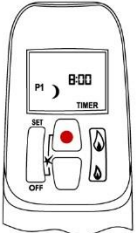

Setting P1 OFF Time

- Briefly press **SET** button to scroll to setting P1 OFF time. P1  (moon) is displayed and the time flashes.

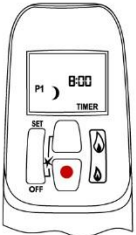

- Set the hour by pressing the  (large flame) button.



- Set the minutes by pressing the  (small flame) button.

Setting P2 ON Time

- Briefly press **SET** button to scroll to setting P2 ON time. P2  (sun) is displayed and the time flashes.
- See instructions SETTING P1 ON TIME.

Setting P2 OFF Time



- Briefly press **SET** button to scroll to setting P2 OFF time. P2  (moon) is displayed and the time flashes.
- See instructions SETTING P1 OFF TIME.
- This concludes programming Timers P1 and P2. Press **OFF** or wait. The handset will automatically save your changes.

MANUAL OPERATION

(Only possible, when MANUAL knob is used)

Access to the pilot burner is only required for ignition with a match.

When turning main valve knob, do not force. Knob has a slip clutch that clicks until the end stops are reached. This allows for manual flame height adjustment as well as adjustment to pilot standby position.

1. **STOP!** Read the safety information included before proceeding.
2. Turn main valve knob to the **OFF**, full clockwise  position.
3. Turn MANUAL knob to the **MAN**, full clockwise  position.
4. Place ON/OFF switch (if equipped) in **O** (OFF position).
5. Wait five (5) minutes to clear out any gas. Verify that no gas is in the area around the appliance, including near the floor. **If you detect gas STOP! Follow "WHAT TO DO IF YOU SMELL GAS" in the safety information on page 2.** If no gas is present, proceed to step 6.
6. Place ON/OFF switch (if equipped) in **I** (ON position).
7. With the MANUAL knob in **MAN** position a manual pilot valve operator and piezo ignitor (optional) are accessible.
8. Fully push down manual pilot valve operator and hold in, to start pilot gas flow (see figure 25, page 21).

Ignition with match:



Immediately light the pilot with a match, while continuing to hold in the manual pilot valve operator for about one (1) minute after the pilot is lit. Release manual pilot valve operator. If pilot does not stay lit, wait five (5) minutes and repeat.

Ignition with piezo ignitor:

Change the ignition cable from the receiver to the valve (see figure 25, page 21). Push in the piezo ignitor to ignite. If pilot does not stay lit, wait five (5) minutes and repeat.

▲ WARNING

If the pilot does not stay lit after several tries, turn the gas control knob (main valve knob) to **OFF** and proceed to step 12.

9. If applicable, replace pilot access panel before proceeding.
10. Turn MANUAL knob to the **ON**, full counterclockwise  position.
11. Turn main valve knob to the full **ON**, full counterclockwise  position.
12. If the appliance will not operate, follow the instructions "TURN OFF GAS TO APPLIANCE" (page 21).

TO TURN OFF GAS TO APPLIANCE

1. Place ON/OFF switch (if equipped) in **O** (OFF position).
2. If gas control is accessible turn main valve knob to the **OFF** full clockwise ↻ position.
3. Replace appliance access cover (if applicable).

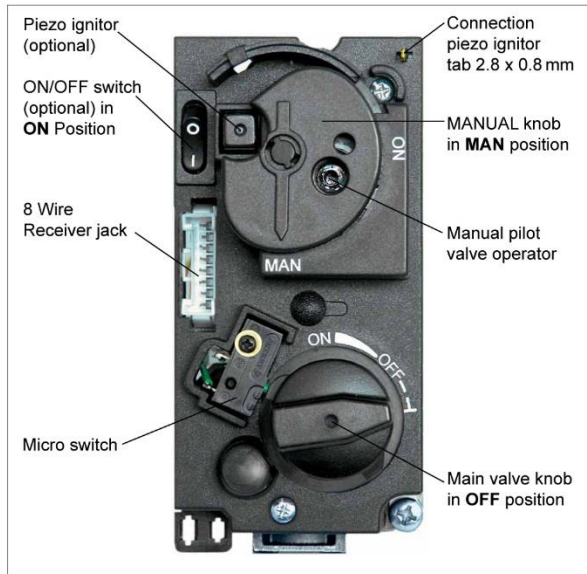

Figure 25: Combination control, cover

AUTOMATIC SHUT OFF**Low Battery Receiver**

- With low battery power in the receiver the system shuts off the fire completely. This will not happen if the power supply is interrupted.

Five Day Shut Off (CSA version)

- The system shuts off the fire completely if there is no change in flame height for 5 days.

Second Thermocouple Shut Off

- Second Thermocouple Option: The system shuts off the fire if the main burner does not completely ignite approximately 20 seconds after ignition or after pushing the 🔥 (large flame) button.

NOTE: Before the next ignition there is a 2 minute waiting period.

ENGLISH

AUTOMATIC TURN DOWN**6 Hour no Motor Movement**

(CSA version)

- Manual Mode/Temperature/Timer Mode: The valve will turn to pilot flame if there is no change in flame height for a 6 hour period. In Temperature/Timer Mode if the ambient room temperature changes, the flame height will adjust automatically to maintain set temperature, and the fire will continue to function normally. The valve will turn to pilot flame if the set temperature and the ambient room temperature remain the same over a 6 hour period.

Receiver Overheating

(only if module is connected)

- Valve turns to pilot flame if the temperature in the receiver is higher than 140°F (60°C). The main burner comes back on only when the temperature is below 140°F (60°C).

1 Hour Turn Down for Special Receiver

(bedroom fireplaces only)

- The valve will turn to pilot flame if there is no change in flame height over a 1 hour period.

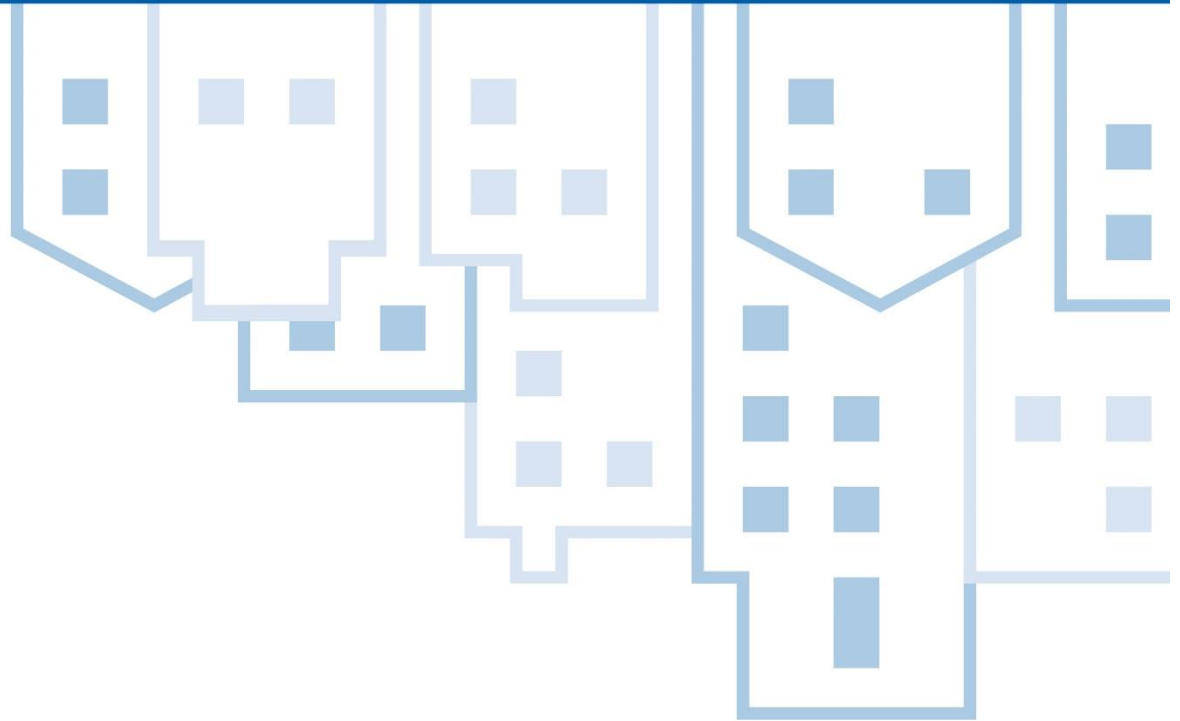

MERTIK MAXITROL®

Exclusive Distributor Europe
for Maxitrol Company

Mertik Maxitrol GmbH & Co. KG
Warnstedter Str. 3
06502 Thale
Germany
Tel: + 49 3947 400-0
Fax: + 49 3947 400-200
www.mertikmaxitrol.com

MAXITROL®

Exclusive Distributor North America
for Mertik Maxitrol

Maxitrol Company, Inc.
23555 Telegraph Rd., PO Box 2230
Southfield, MI 48037-2230
USA
Tel: +1 248-356-1400
Fax: +1 248-356-0829
www.maxitrol.com

GV60-B-OI-EN-01.2013

GV60 Remote Electronic Ignition and Control System

For 2008 and 2010 GV60 Systems Not Using Manually Selected Codes.

INSTALLER TROUBLESHOOTING GUIDE

FOR OEM USE ONLY

▲ WARNING

Read the INSTALLATION AND OPERATING INSTRUCTIONS for the GV60 REMOTE ELECTRONIC IGNITION AND CONTROL SYSTEM carefully. Failure to follow them could result in a fire or explosion causing property damage, personal injury, or loss of life. Service and installation must be performed by a trained and experienced service technician.

WHAT TO DO IF YOU SMELL GAS

- Do not operate any appliance.
- Do not touch any electrical switch; do not use any phone in your building.
- Immediately evacuate the area and contact the gas supplier. Follow the gas supplier's instructions.
- If you cannot reach the gas supplier, call the fire department.

This control **must** be installed and operated **strictly** in accordance with the instructions of the OEM and with all applicable government codes and regulations, e.g. plumbing, mechanical, and electrical codes and practices. These instructions do not supersede OEM's installation or operating instructions.

Do **NOT** use a Mertik Maxitrol control if you suspect it has been subjected to high temperatures, damaged, tampered with, or taken apart. Do **NOT** use a Mertik Maxitrol control if you suspect

it has been under water or that liquids has seeped into the Valve. Any of these incidents can cause leakage or other damage that may affect proper operation and cause potentially dangerous combustion problems.

Damper position must be in accordance with Manufacturer's Installation Instructions and all applicable Standards. Failure to follow them could result in a fire or explosion causing property damage, personal injury, or loss of life.

Use only your hand to push in or turn the gas control knobs. Never use tools. If a knob will not push in or turn by hand, do not try to repair it. Call a qualified service technician. Force or attempted repair can result in a fire or explosion.

Do not store or use gasoline or other flammable vapors and liquids in the vicinity of this control or other appliances.

ELECTRIC SHOCK HAZARD





This control must be electrically wired and operated in accordance with all codes and local regulations. Service and installation must be performed by a trained and experienced service technician. Do not use the control if you suspect it may be damaged.

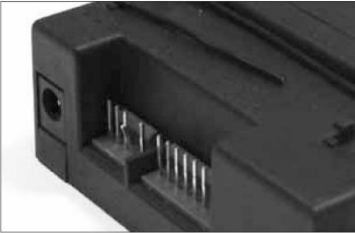

NOTICE

Wiring of the Valve and Receiver must be completed before installing any batteries and starting ignition.

If the Receiver is in a metal box or metal heat shield that is separated from the Valve and is not connected by a secured ground, an additional wire is recommended to connect the metal box to the Valve.

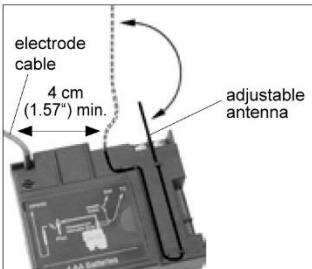
	OBSERVED PROBLEM	POSSIBLE CAUSE	REMEDY
A	Will not operate with Touch Pad / Wall Switch / Switch Panel.	1. Bent pin	Straighten pin, replace Touch Pad, Switch and/or cable (see figure 1).  Figure 1
B	Will not operate with Handset	1. Transmitter batteries low	Replace Transmitter batteries. Quality alkaline recommended.
		2. Receiver batteries low	Replace Receiver batteries with 1.5V "AA" quality alkaline batteries.
		3. Optional Mains Adapter not operating properly	Check Mains Adapter.
		4. Check coding of Transmitter and Receiver (Initial sync.)	Learn new code (reset). See label on Receiver.
		5. Transmitter distance limited	1. Straighten the antenna. 2. Replace Receiver. See wiring diagrams, pg. 8–12, in the operating/installation instructions for the GV60

OBSERVED PROBLEM	POSSIBLE CAUSE	REMEDY
<p>C No transmission: (motor does not turn)</p>	<p>1. Dead batteries</p>	<p>Replace the batteries in the Receiver and/or Remote Handset (quality Alkaline recommended).</p> <p>▲ WARNING</p> <p>Do not use metal tools to remove batteries. Doing so will render the Receiver inoperable (see figure 2).</p>  <p>Figure 2</p> <p>Application with internal and external battery box:</p> <p>▲ WARNING</p> <p>Battery clip (see figure 3) must not come into contact with metal parts after unplugging the external battery holder, because there is voltage stored in the Receiver.</p>  <p>Figure 3</p>
	<p>2. Receiver must learn new code.</p>	<p>Press and hold the Receiver's reset button (see figure 4) until you hear 2 acoustic signals. After the second, longer acoustic signal, release the reset button. Within the subsequent 20 seconds press the  (small flame) button on the Remote Handset until you hear an additional long acoustic signal confirming the new code is set.</p>  <p>Figure 4</p>
	<p>3. The Receiver is surrounded by metal, reducing the transmission range.</p>	<p>Change the position of the adjustable antenna.</p> <p>▲ WARNING</p> <p>Make sure that the adjustable antenna is not too close to the electrode cable and ignition coil (beneath the cover). It will damage the Receiver (see figure 5).</p>  <p>Figure 5</p>

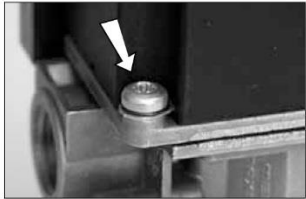
OBSERVED PROBLEM	POSSIBLE CAUSE	REMEDY
C <i>Continued</i> No transmission: (motor does not turn)	4. Receiver	Replace Receiver and reprogram code (see OBSERVED PROBLEM C, REMEDY to POSSIBLE CAUSE 2).
	5. Transmitter	Replace the Transmitter and reprogram code (see OBSERVED PROBLEM C, REMEDY to POSSIBLE CAUSE 2).
	6. Bent pins on 8 Wire Connector on the Valve and Receiver (see figures 6 and 7)	Straighten pins on 8 Wire Connector.  Figure 6
	7. Wiring at Valve damaged	Replace Valve.
	8. IR-Eye (Infrared remote only)	Replace (check and change).
D No ignition; no tone:	1. Receiver	Replace Receiver and reprogram code (see OBSERVED PROBLEM C, REMEDY to POSSIBLE CAUSE 2).
E No Ignition; one 5 second continuous tone:	1. ON/OFF Switch is in (O) OFF position.	Push Switch to (–) ON position (see figure 7).  Figure 7 ON/OFF Switch 8 Wire Connector
	2. Loose wire	Secure wire.
	3. Receiver	Replace Receiver and reprogram code (see OBSERVED PROBLEM C, REMEDY to POSSIBLE CAUSE 2).
	4. Bent pins on 8 Wire Connector (see figures 7 and 9)	Straighten pins on 8 Wire Connector.
	5. Valve	Replace Valve. Do not overtighten the Thermocouple Interrupter.
F Ignition stops after the first spark	1. Loose ground connection at the Valve  Figure 8	Check ground connection at the Valve and tighten screw (see figure 8).
G No pilot flame but spark:	1. No gas supply	Check the gas supply.
	2. Air in the pilot supply line	Purge the line or start ignition several times.
	3. No spark at Pilot Burner	Check manufacturer's instructions for pilot setup; check wiring connection. Check for spark in location along Cable.
	4. Valve	Replace Valve. Do not overtighten the Thermocouple Interrupter.

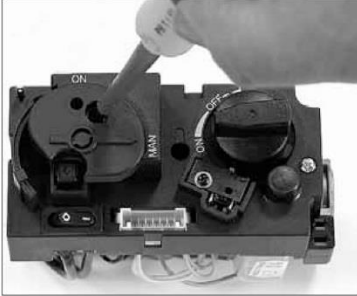
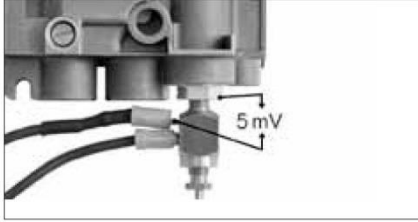
OBSERVED PROBLEM	POSSIBLE CAUSE	REMEDY
<p>G <i>Continued</i> No pilot flame but spark:</p>	<p>5. Receiver</p>	<p>Replace Receiver and reprogram code (see OBSERVED PROBLEM C, REMEDY to POSSIBLE CAUSE 2).</p>
<p>H Pilot is lit and sparking stops. Valve shuts off after 10...60 seconds. Valve does not operate manually:</p> <p>NOTE: For manual operation turn the Valve knob to the manual position and hold the safety magnet open with a pen for approximately 60 seconds (see figure 9).</p>  <p>Figure 9</p>	<p>6. Thermocouple circuit wired incorrectly</p> <p>1. Not enough voltage generated from the Thermocouple or too much resistance in the circuit.</p> <p>NOTE: To find which part of the circuit is causing the problem, a checklist for each application can be prepared using an Excel calculation available from Meritik Maxitrol.</p> <p>Possible parts causing excessive resistance are: ON-OFF Switch, Temperature Switches, Thermocurrent Connections, Receiver.</p>	<p>Check polarity of the Thermocouple Wires.</p> <p>Use a digital multimeter set in the mV range and measure the voltage by connecting the test leads to the spade connector. Spade connector is located on the outer surface, directly beside the magnet nut (see figure 10). The available voltage must be at least 5mV. The manufacturer must specify the drop time for the application. The drop time can be measured after the Thermocouple is heated.</p>  <p>Figure 10</p>
<p>I Frequent beeps for 3 seconds while motor turns.</p>	<p>2. Thermocouple</p> <p>3. Low inlet pressure to Valve</p> <p>4. Valve</p>	<p>Replace Thermocouple.</p> <p>Confirm sufficient inlet pressure to the Valve. Adjust or replace inlet regulator if necessary.</p> <p>Replace Valve. Do not overtighten the Thermocouple Interrupter.</p>
<p>J Pilot flame lights but there is no main gas flow</p>	<p>1. Batteries (Receiver) are low</p>	<p>Replace batteries (Quality Alkaline recommended).</p> <p>▲ WARNING Do not use metal tools to remove batteries. Doing so will render the Receiver inoperable (see figure 2).</p>
<p>K Latching Solenoid does not work.</p>	<p>1. Manual override knob (if equipped) is in MAN position.</p> <p>2. Valve turned down to pilot flow.</p> <p>3. Valve</p>	<p>Turn manual override knob to ON position (see figure 7).</p> <p>Turn flame to high fire by pressing up button on remote handset.</p> <p>Replace Valve. Do not overtighten the Thermocouple Interrupter.</p>
<p>L Fan/Light do not work.</p>	<p>1. Loose connection</p> <p>2. Latching Solenoid</p> <p>3. Receiver</p> <p>4. Handset</p>	<p>Check connection is tight and pins are straight.</p> <p>Replace Latching Solenoid</p> <p>Replace Receiver and reprogram code (see OBSERVED PROBLEM C, REMEDY to POSSIBLE CAUSE 2).</p> <p>Check that the Handset shows the AUX-symbol if you press SET + UP</p>
<p>L Fan/Light do not work.</p>	<p>1. No Mains Power</p> <p>2. Wired incorrectly</p> <p>3. Fan and/or Light do not function.</p>	<p>Confirm Mains Power supply.</p> <p>Check Light and Fan are plugged into the correct connector. Check wiring.</p> <p>Replace Fan or Light.</p>

	OBSERVED PROBLEM	POSSIBLE CAUSE	REMEDY
L	<i>Continued</i> Fan/Light do not work.	4. V-module	Replace V-module.
		5. Receiver	Replace Receiver and reprogram code (see OBSERVED PROBLEM C, REMEDY to POSSIBLE CAUSE 2).
M	Relay with Cable or Power Flue does not work.	1. Wired incorrectly.	Check wiring and Relay contacts.
		2. Relay with Cable or Power Flue Control does not function.	Replace Relay/Power Flue Control.
		3. Receiver	Replace Receiver and reprogram code (see OBSERVED PROBLEM C, REMEDY to POSSIBLE CAUSE 2).
		4. Handset	Check that the handset label shows the right part number.
N	Electronics do not work: (Motor does not turn, no beeping, or no sparks).	1. The Receiver is in a metal box or metal heat shield, this box is separated from the Valve, and is not connected by a secure ground.	An additional wire is required to connect the metal box to the Valve (see figure 11). Press the Receiver's reset button (see figure 4).

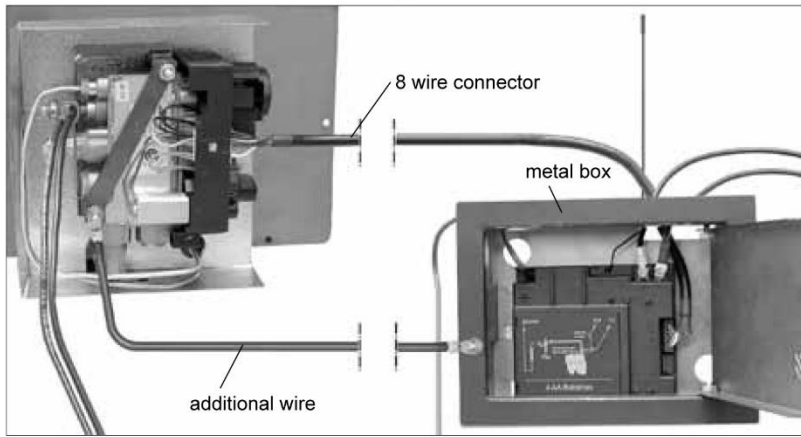

Figure 11

LIMITED WARRANTY

Refractory and Ceramic Fiber

Hargrove gas logs carry a limited lifetime warranty against any manufactured defect or breakage. A replacement will be available from the dealer at which the appliance was purchased. This warranty does not cover breakage caused by excessive handling once installed and fired.

Burner & Grate

If the burner or grate fails due to deterioration within five (5) years of the verified purchase date, a free replacement will be made available from the dealer at which the appliance was purchased.

Valves, Remote Controls, & Switching Devices

Hargrove warrants all valves, remote controls and switching devices against manufacturing defects which appear within two (2) years of the verified purchase date. Warranty does not cover products that have been damaged by misuse from overheating. Before any product is returned a Return Goods Authorization number (RGA) must be issued by Hargrove's Customer Service Department. All returns must be accompanied by an explanation of the problem and all necessary parts.

All Other Parts

If any assembled part should fail to operate or be found defective which appear within two years of the verified purchase date, a replacement will be available from the dealer at which the appliance was purchased.

Buyer shall notify Hargrove Mfg Corp. of any defect covered by this warranty no later than thirty (30) days after defect is discovered. Failure to provide notice within thirty (30) days shall void the limited warranty.

WHAT IS NOT COVERED

1. Removal and reinstallation costs.
2. Labor costs for replacement or repairs.
3. Transportation or shipping cost.
4. The cost of a service call to diagnose trouble.
5. Painted Surfaces.
6. Damage or defect caused by improper installation, accident, misuse, abuse, alteration, or authorized service technician.
7. Replacement of burner or combustion chamber resulting from improper storage of the appliance.

LIMITATIONS AND EXCLUSIONS

1. No one has authority to add to or vary this limited warranty, or to create for Hargrove Manufacturing Corporation any other obligation or liability in connection with this appliance.
2. Any implied warranty applicable to this appliance is limited in duration to the same period of time as this written Warranty. Some states do not allow limitations on how long an implied warranty lasts, so the above limitations may not apply to you.
3. HARGROVE MANUFACTURING CORPORATION WILL NOT BE LIABLE FOR INCIDENTAL, CONSEQUENTIAL, SPECIAL OR CONTINGENT DAMAGES YOU MIGHT SUFFER AS A RESULT OF A CLAIM UNDER THIS WRITTEN WARRANTY OR ANY IMPLIED WARRANTY. Some states do not allow the exclusion or limitation of incidental or consequential damages, so the above limitations or exclusion may not apply to you.
4. This warranty applies only to the original purchaser and may not be transferred or assigned.
5. If you cannot verify the purchase date of the appliance, the warranty period will begin on the date of which the appliance was manufactured.
6. Replacement or repair parts are warranted for the remaining period of the original part warranty. Warranty parts must be obtained through authorized dealers of this product who will provide original factory replacement parts. Failure to use original factory replacement parts voids this warranty.
7. The maximum liability of Hargrove Mfg Corp. in connection with this limited warranty shall not in any case exceed the contract price paid for the product claimed to be defective or unsuitable.
8. Purchaser or user agrees to hold Hargrove Mfg Corp. harmless from any and all claims by the buyer as a result of injury or damage to an ultimate user or other person caused by the product sold herein by the seller to the buyer, whether the injury or damage results from the assembly, installation, operation, shipment, storage, or manufacture of this product. Hargrove Mfg Corp. makes no warranties, expressed or implied, other than those expressly stated herein.

YOUR DUTIES

This appliance must be installed by a qualified installer, operated and maintained in accordance with all applicable codes and the instructions furnished with the appliance. You must provide a receipt verifying the purchase date of the appliance when making a warranty claim with the dealer from which the appliance was purchased.

This warranty gives you specific legal rights, and you may also have other rights, which vary from state to state.

CONTACT INFO: Hargrove Manufacturing Corp.
Tele: (800) 725-4166

Section

30.01: Purpose

30.02: Scope

30.03: Definitions

30.04: Installation

30.04: Maintenance and Operation

30.01: Purpose

The purpose of 527 CMR 30.00 is to provide requirements for the installation, maintenance, and operation of unvented propane or natural gas-fired space heaters.

30.02: Scope

527 CMR 30.00 shall apply to unvented propane or natural gas-fired space heaters installed in occupancies used in whole or in part for habitation on or after April 1, 2004. 527 CMR 30.00 shall not apply to unvented propane or natural gas-fired space heaters not used in habitated spaces or those installed in accordance with 527 CMR 20.

Malfunction, shall mean a condition where a space heater fails to operate properly as provided in the manufacturer's instructions.

Oxygen Depletion Safety Shutoff System (ODS): A device utilized to shut off the gas supply to the pilot or main burner when the oxygen in the surrounding atmosphere is depleted to the percent concentration developed by the manufacturer, but under no circumstances shall the concentration be less than 18 percent oxygen concentration.

Primary Heat: A heat source that is permanently installed and used exclusively to provide heat to the entire structure (e.g. forced hot water, forced hot air) by means of a central furnace or boiler which has a permanent fuel source (e.g. oil, natural gas or LPG) or electric heat. 527 CMR 30.03. Primary Heat shall not include fireplaces or wood stoves.

Unvented Natural or Propane Gas-Fired Space Heater: A permanently installed stand alone gas-fired unvented room heater or gas-fired unvented decorative room heater for connection to the house fuel supply system which utilizes natural gas or propane. Unvented gas-fired space heaters may be used only for supplemental heat and/or decorative purposes and under no circumstances shall they provide a primary heat source. Unvented gas-fired space heaters shall comply with ANSI Standard Z21.11.2 – 2000 edition, Volume II.

30.04: Installation

- (1) A permit shall be obtained from the head of the fire department and the local or state gas inspector having jurisdiction for the installation of all unvented propane or natural gas-fired

space heaters. Said permits shall be conditioned upon final inspection and approval of installation by the head of the fire department and the local or state gas inspector having jurisdiction. A copy of the manufacturer's installation/operating literature shall be submitted with each permit application. Before operation, the Head of the Fire Department and the local or state gas inspector shall inspect the installation for compliance with 527 CMR and 248 CMR (Board of State Examiners of Plumbers and Gas Fitters).

- (2) Unvented propane or natural gas-fired space heaters shall conform to ANSI Z21.11.2, be equipped with an oxygen depletion safety (ODS) shutoff system and be listed and approved in accordance with 248 CMR.
- (3) Unvented propane or natural gas-fired space heaters shall be installed in accordance with their listings and the manufacturer's instructions. Proper clearances to combustibles shall be maintained. In no case shall the clearances be such as to interfere with combustion air and accessibility.
- (4) Installations shall be of a permanent type, with a permanently piped fuel supply in accordance with 248 CMR. LPG appliances shall be subject to the storage requirements in accordance with 527 CMR 6.00. Portable unvented propane or natural gas-fired space heaters shall be prohibited.
- (5) Unvented propane or natural gas-fired space heaters shall be prohibited in bedrooms and bathrooms.
- (6) Space heaters shall be properly sized for the room or space of installation, but shall not exceed a maximum of 40,000 BTU input per room or space.
- (7) In occupancies with an unvented propane or natural gas-fired space heater, at least one listed carbon monoxide detector shall be installed and maintained in any room or space where said heater has been installed in accordance with the manufacturer's instructions. Any building wherein said heater is to be installed shall, as a precondition to such installation, have working smoke detectors installed and maintained in accordance with the requirements of 780 CMR (State Board of Building Regulations and Standards) in effect at the time of construction or if no said requirement was in effect at the time of construction, installed as provided for in M.G.L.c. 148, §26E.
- (8) In rooms and buildings served by an unvented propane or natural gas-fired space heater, a primary source of heat, which is operable, shall be permanently installed and maintained in said building in accordance with 105 CMR (Department of Public Health).
- (9) Sellers of unvented propane or natural gas-fired space heaters shall provide to each purchaser a copy of 527 CMR 30.00 upon sale of the unit.

30.05: Maintenance and Operation

- (1) The maintenance and operation of unvented propane or natural gas-fired space heaters shall be in accordance with the manufacturer's instructions. The manufacturer's instructions shall be left with the appliance and made available for any public official.
- (2) Any malfunction of an unvented space heater shall forthwith be reported by the owner to the head of the local fire department.

REGULATORY AUTHORITY

527 CMR 30.00 M.G.L. c. 148, §25A